

OPERATING INSTRUCTIONS

INDOOR UNIT
MCFZ-A12WV



OPERATING INSTRUCTIONS

For customers

- To use this unit correctly and safely, be sure to read this operating instructions before use.

Bedienungsanleitung

Für Kunden

- Um diese Einheit richtig und sicher zu verwenden, unbedingt diese Bedienungsanleitung vor der Inbetriebnahme durchlesen.

NOTICE D'UTILISATION

A l'attention des clients

- Pour avoir la certitude d'utiliser cet appareil correctement et en toute sécurité, veuillez lire attentivement cette notice d'instructions avant de mettre l'appareil en fonction.

GEbruIKSAANWIJZING

Voor de klant

- Om dit apparaat op de juiste manier en veilig te gebruiken, dient u eerst deze gebruiksaanwijzing aandachtig door te lezen.

MANUAL DE INSTRUCCIONES

Para los clientes

- Para emplear correctamente este aparato y por razones de seguridad debe leer este manual de instrucciones de manejo antes de su utilización.

LIBRETTO D'ISTRUZIONI

Per gli utenti

- Per utilizzare correttamente quest'unità, leggere questo libretto d'istruzioni attentamente e per intero.

ΟΔΗΓΙΕΣ ΛΕΙΤΟΥΡΓΙΑΣ

Για τον πελάτη

- Για να χρησιμοποιήσετε αυτή την μονάδα σωστά και με ασφάλεια, βεβαιωθείτε ότι έχετε διαβάσει αυτό το εγχειρίδιο οδηγιών πριν από την χρήση.

INSTRUÇÕES DE OPERAÇÃO

Para os clientes

- Para utilizar esta unidade correctamente, certifique-se de que lê estas instruções de operação antes da utilização.

BRUGSANVISNING

Til kunden

- Læs denne brugsanvisning før brugen så korrekt og forsvarlig anvendelse af klimaanlægget sikres.

BRUKSANVISNING

För kunder

- För att använda enheten på rätt och säkert sätt ska denna bruksanvisning läsas innan enheten tas i bruk.

İŞLETME TALİMATLARI

Satın alıcılar için

- Bu birimi doğru ve güvenli olarak çalıştırmak için, kullanmadan önce bu işletme talimatlarını mutlaka okuyun.

РУКОВОДСТВО ПО ЭКСПЛУАТАЦИИ

Для пользователей

- Для обеспечения правильного и безопасного использования прибора следует до начала его эксплуатации внимательно прочитать данное руководство.

English

Deutsch

Français

Nederlands

Español

Italiano

Ελληνικά

Português

Dansk

Svenska

Türkçe

Русский



CONTENTS

SAFETY PRECAUTIONS	2
NAME OF EACH PART	3
PREPARATION BEFORE OPERATION	4
I FEEL... AUTO OPERATION	6
AUTO CHANGEOVER... AUTO MODE OPERATION	7
MANUAL OPERATION (COOL, DRY, HEAT)	7
AIR FLOW VELOCITY AND DIRECTION ADJUSTMENT	8
ECONO COOL OPERATION	9
TIMER OPERATION (ON/OFF TIMER)	9
WHEN THE AIR CONDITIONER IS NOT GOING TO BE USED FOR A LONG TIME	9
MAINTENANCE	9
CLEANING THE AIR FILTER/THE DEODORIZING FILTER (OPTION)	10
REPLACEMENT OF THE DEODORIZING FILTER (OPTION)/AIR CLEANING FILTER (OPTION)	10
BEFORE CONTACTING THE SERVICE REPRESENTATIVE, CHECK THE FOLLOWING AGAIN	11
WHEN YOU THINK THAT TROUBLE HAS OCCURRED	11
INSTALLATION, RELOCATION AND INSPECTION	12
SPECIFICATIONS	12

SAFETY PRECAUTIONS







- Since rotating parts and parts which could cause an electric shock are used in this product, be sure to read these "Safety Precautions" before use.
- Since the cautionary items shown here are important for safety, be sure to observe them.

Marks and their meanings

-  **WARNING:** Incorrect handling could cause a serious hazard, such as death, serious injury, etc. with a high probability.
-  **CAUTION:** Incorrect handling could cause a serious hazard depending on the conditions.

Meanings of symbols used in this manual

- The colour of the sticker affixed to the unit is written in the parentheses.





-  : Be sure not to do.
-  : Be sure to follow the instruction.
-  (Black) : Never insert your finger or stick, etc.
-  (Black) : Never step onto the indoor/outdoor unit and do not put anything on them.
-  : Danger of electric shock. Be careful.
-  : Be sure to disconnect the power supply plug from the power outlet.
-  : Be sure to shut off the power.

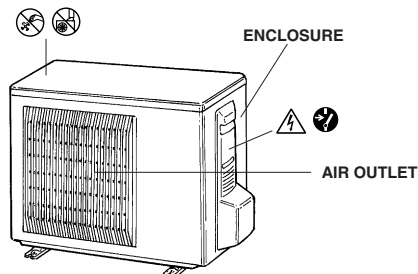
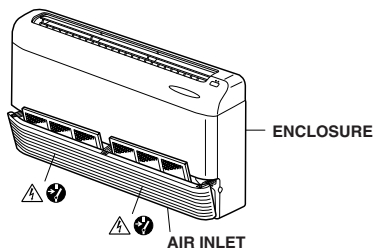

- After reading this manual, keep it together with the installation manual in a handy place for easy reference.

Warning mark positions



- This air conditioner is NOT intended for use by children or infirm persons without supervisions.

 WARNING	
	<p>Do not use intermediate connection of the power supply cord or the extension cord and do not connect many devices to one AC outlet.</p> <ul style="list-style-type: none"> • A fire or an electric shock may result from poor contact, poor insulation, exceeding the permissible current, etc.
	<p>Remove dirt from the power supply plug and securely insert the plug into the outlet.</p> <ul style="list-style-type: none"> • If dirt adheres to the plug or insertion is incomplete, it may cause a fire or an electric shock.
	<p>Do not scratch or process the power supply cord, etc.</p> <ul style="list-style-type: none"> • Do not put heavy object on the power supply cord and do not scratch or process the cord. The cord may be damaged and this may cause a fire or an electric shock.
	<p>Do not turn the breaker off/on and/or disconnect/connect the power supply plug during operation.</p> <ul style="list-style-type: none"> • This may cause a fire due to spark, etc. • Be sure to turn off the breaker and/or disconnect the power supply plug absolutely after switching the indoor unit off with the remote controller.
	<p>Do not expose your skin directly to cool air for a long time.</p> <ul style="list-style-type: none"> • This could damage your health. <p>Installation, repairs or relocation should not be done by the customer.</p> <ul style="list-style-type: none"> • If this is done incorrectly, it may cause a fire, an electric shock, or injury from the unit falling, water leaking, etc. Consult your dealer. • If the power supply cord is damaged, it must be replaced by the manufacturer or its service agent in order to avoid a hazard.
 	<p>Do not insert your finger or a stick, etc. into the air inlet/outlet.</p> <ul style="list-style-type: none"> • Since the fan rotates at high speed, this may cause an injury. • Young children should be supervised to ensure that they do not play with the air conditioner.
 	<p>When an abnormality (burning smell, etc.) occurs, stop the air conditioner and disconnect the power supply plug and/or turn off the breaker.</p> <ul style="list-style-type: none"> • If the unit continues to be operated in an abnormal condition, it may cause a fire, trouble, etc. In this case, consult your dealer.

 CAUTION	
	<p>When the air filter is to be removed, do not touch the metal part of the indoor unit.</p> <ul style="list-style-type: none"> • This may cause an injury.
	<p>Do not touch the air inlet or aluminum fin of the outdoor unit.</p> <ul style="list-style-type: none"> • This may cause an injury.
	<p>Do not put a vase or glass on the indoor unit.</p> <ul style="list-style-type: none"> • Water dropping into the indoor unit may deteriorate the insulation, causing electric shock.
	<p>Do not use an insecticide or flammable spray.</p> <ul style="list-style-type: none"> • This may cause a fire or deformation of the cabinet.
	<p>Do not put a pet or houseplant where it will be exposed to direct airflow.</p> <ul style="list-style-type: none"> • This could injure the pet or plant.
	<p>Do not place other electric appliances or furniture under the indoor/outdoor unit.</p> <ul style="list-style-type: none"> • Water may drip down from the unit, and this may cause damage or malfunction to them.
	<p>Do not leave the unit on an installation stand which is damaged.</p> <ul style="list-style-type: none"> • The unit may fall and this may cause an injury.
	<p>Do not step onto an unstable bench when maintaining the unit, etc.</p> <ul style="list-style-type: none"> • This may cause an injury, etc. if you fall down.
	<p>Do not pull the power supply cord.</p> <ul style="list-style-type: none"> • The core wire of the power supply cord may be disconnected and this may cause a fire.
	<p>Do not charge or disassemble the batteries and do not throw them into a fire.</p> <ul style="list-style-type: none"> • This may result in leakage, fire or an explosion.
	<p>Do not operate the unit for a long time in high humidity, e.g. leaving a door or window open.</p> <ul style="list-style-type: none"> • In the cooling mode, if the unit is operated in a room with high humidity (80% RH or more) for a long time, water condensed in the air conditioner may drop and wet or damage furniture, etc.

SAFETY PRECAUTIONS

⚠ CAUTION

⊘	Do not operate the unit at low outside temperature (less than -10°C) in the cooling mode.
	<ul style="list-style-type: none"> In the cooling mode, if the unit is operated at low outside temperature (less than -10°C), water condensed in the air conditioner may drop and wet or damage furniture, etc.
	Do not use the unit for special purposes.
⚠	<ul style="list-style-type: none"> Do not use this air conditioner to preserve precision devices, food, animals, plants and art objects. This may cause deterioration of quality, etc.
	Do not put a stove, etc. where they are exposed to direct airflow.
⚠	<ul style="list-style-type: none"> This may cause imperfect combustion.
	When the unit is to be cleaned, switch it off and disconnect the power supply plug and/or turn off the breaker.
	<ul style="list-style-type: none"> Since the fan rotates at high speed during operation, this may cause an injury.
	When the unit is not going to be used for a long time, disconnect the power supply plug and/or turn off the breaker.
	<ul style="list-style-type: none"> Otherwise, dirt may collect and this may cause a fire.
	Replace the 2 batteries with new ones of same type.
	<ul style="list-style-type: none"> Using an old battery together with a new one may result in heat generation, leakage or an explosion.
⚠	If liquid from the batteries gets onto your skin or clothes, wash it well with clean water.
	<ul style="list-style-type: none"> If liquid from the batteries gets into your eyes, wash them well with clean water and consult a doctor at once.
⚠	Ventilate well in using the unit with a stove, etc.
	<ul style="list-style-type: none"> An oxygen shortage may occur.
⚠	Do not operate switches with wet hands.
	<ul style="list-style-type: none"> This may cause an electric shock.
⚠	Do not clean the air conditioner with water.
	<ul style="list-style-type: none"> Water may enter the unit and degrade the insulation. This may cause an electric shock.
⚠	Do not step or put anything on the indoor/outdoor unit.
	<ul style="list-style-type: none"> This may cause an injury, etc. if you or something falls down.

For installation

⚠ WARNING

- Consult your dealer for installation of the air conditioner.

⚠ CAUTION

⊘	Do not install the unit where flammable gas could leak.
	<ul style="list-style-type: none"> If gas leaks and collects around the unit, it may cause an explosion.
⚠	Earth the unit.
	<ul style="list-style-type: none"> Do not connect the earth to a gas pipe, water pipe, lightning rod or the earth of a telephone. If the earthing is incorrect, it may cause an electric shock.
	Install an earth leakage breaker depending on the place where the air conditioner is to be installed (humid places, etc.).
⚠	Drain should be fully drained.
	<ul style="list-style-type: none"> If the drainage route is incomplete, water may drop from the unit. This may wet and damage the furniture.

NAME OF EACH PART

Indoor unit (When installed on the floor)

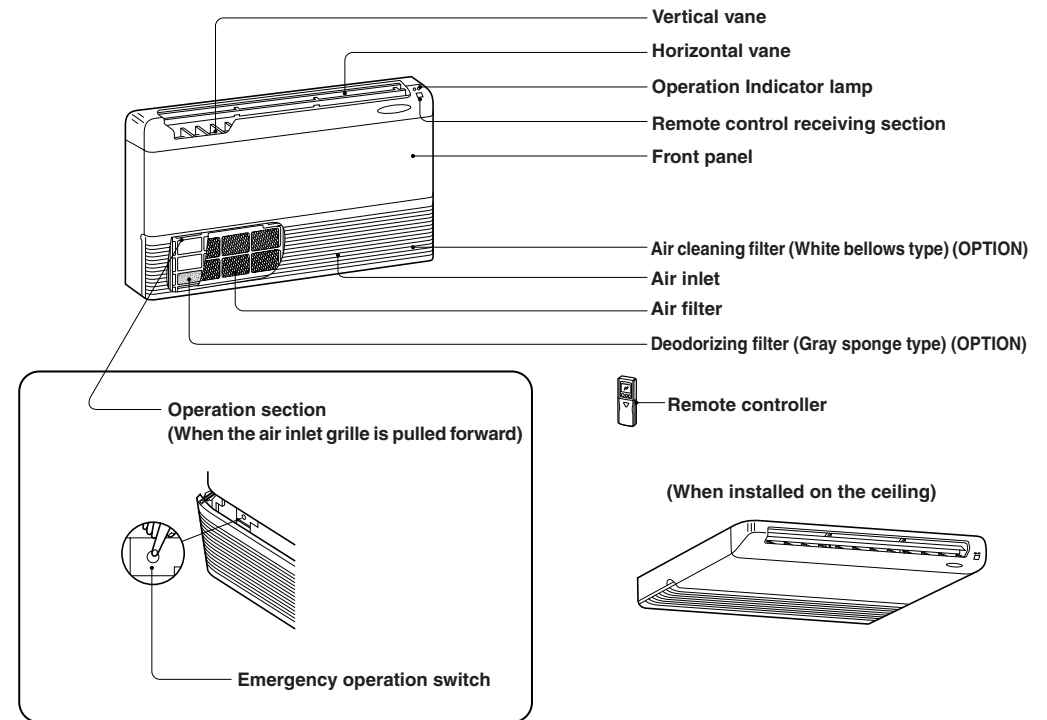

Outdoor unit

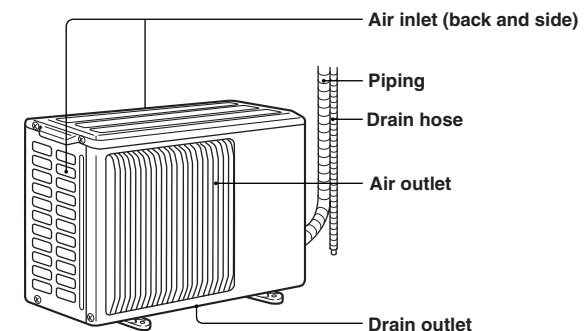

NAME OF EACH PART

Remote controller

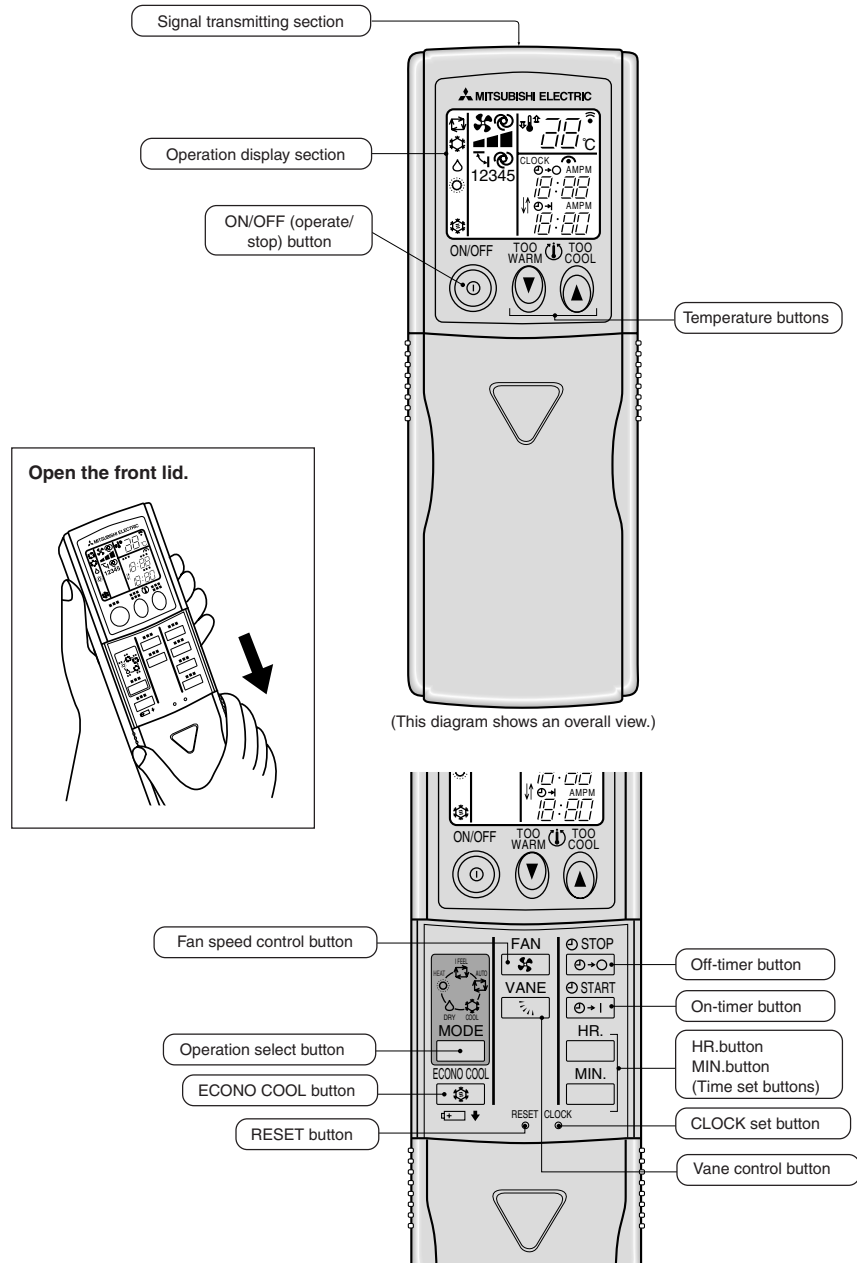

PREPARATION BEFORE OPERATION

Auto restart function

These models are equipped with an auto restart function. If you do not want to use this function, please consult the service representative because the setting of the unit needs to be changed.

Auto restart function is ...

When the indoor unit is controlled with the remote controller, the operation mode, the set temperature and the fan speed are stored in the memory. If a power failure occurs or the main power is turned off during operation, "Auto restart function" sets automatically to start operating in the same mode as the one set with the remote controller just before the shutoff of the main power. (Refer to page 6 for details.)

Indoor unit

Insert the power supply plug into the power outlet and/or turn the breaker on.

WARNING:

Remove dirt from the power supply plug and insert the plug securely.

If dirt adheres to the plug or insertion is incomplete, it may cause a fire or an electric shock.

PREPARATION BEFORE OPERATION

Remote controller

How to set the batteries and the current time

- 1 Remove the front lid and insert batteries. Then reattach the front lid.

Insert the minus pole of the batteries first. Check if the polarity of the batteries is correct.

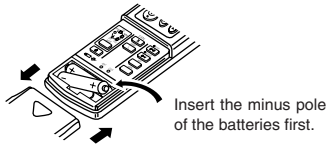

- 2 Press the RESET button.

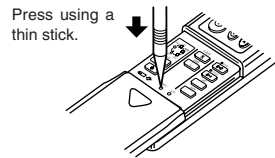

- If the RESET button is not pressed, the remote controller may not operate correctly.

- 3 Press the CLOCK set button.

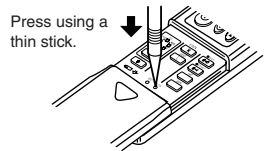

- 4 Press the **HR.** and **MIN.** buttons (TIME SET buttons) to set the current time.

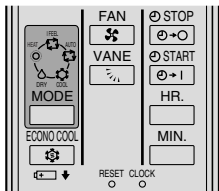

- Each time the **HR.** button is pressed, the set time increases by 1 hour, and each time the **MIN.** button is pressed, the set time increases by 1 minute.

- 5 Press the CLOCK set button again and close the front lid.

Handling of the remote controller

- The range that the signal can reach is about 6 m when the remote controller is pointed at the front of the indoor unit.
- When a button is pressed, one or two beeps will be heard from the indoor unit. If no sound is heard, operate again.
- Use the remote controller carefully. If it is dropped, thrown or it gets wet, the remote controller may not operate.

When installing on a wall, etc.

- Install the remote controller holder in a position where the signal reception sound (beep) can be heard from the indoor unit when the **ON/OFF** button is pressed.

How to install/remove the remote controller

Installing : Insert the remote controller downward.
Removing : Pull it up.

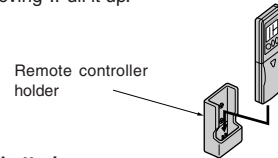

Dry-cell batteries

■ Reference for replacing batteries

Replace the batteries with new AAA alkaline batteries in the following cases:

- When the indoor unit does not respond to the remote control signal.
- When the display on the remote controller becomes dim.
- When a button of the remote controller is pressed, all displays appear on the screen, and then disappear immediately.

Do not use manganese batteries. The remote controller could malfunction.

- The service life of an alkaline battery is about 1 year. However, a battery whose time limit is approaching may be exhausted soon. The recommended usable time limit is indicated (month/year) on the bottom of the battery.
- To prevent liquid leakage, take out all batteries when the remote controller is not going to be used for a long time.

⚠ CAUTION:

If liquid from the batteries gets onto your skin or clothes, wash it well with clean water.

If liquid from the batteries gets into your eyes, wash them well with clean water and consult a doctor at once.

- Do not use rechargeable batteries.
- Replace the 2 batteries with new ones of the same type.
- Dispose of exhausted batteries in the correct manner.

When the remote controller cannot be used (emergency operation)

When the batteries of the remote controller run out or the remote controller malfunctions, the emergency operation can be done using the EMERGENCY OPERATION switch.

- 1 Press the EMERGENCY OPERATION switch.

- Each time the EMERGENCY OPERATION switch is pressed, the unit will operate in order of EMERGENCY COOL MODE, EMERGENCY HEAT MODE and STOP MODE.

However, when the EMERGENCY OPERATION switch is once pressed, the unit will operate in test run for 30 minutes and then the operation mode shifts to EMERGENCY MODE.

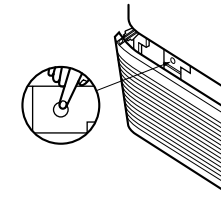

- Details of EMERGENCY MODE are as shown below. However, the temperature control does not work for 30 minutes in test run and the unit is set to continuous operation. The fan speed is set to High in test run and shifts to Medium after 30 minutes.

Operation mode	COOL	HEAT
Set temperature	24°C	24°C
Fan speed	Medium	Medium
Horizontal vane	Auto	Auto

- The operation mode is indicated by the Operation Indicator lamp on the indoor unit as following figure.

Operation Indicator lamp

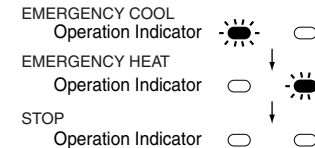

I FEEL... AUTO OPERATION

With the “I FEEL...” auto operation mode, the optimum room condition can be set automatically with a one-touch operation.

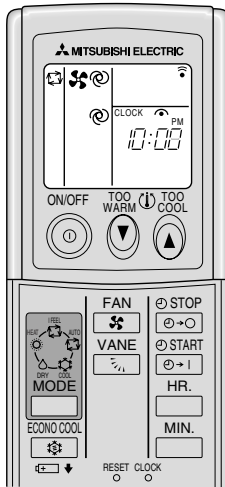

To start operation:

Press the button.

When the “I FEEL...” mode is selected, the air conditioner is automatically controlled at the optimum temperature.

To stop operation:

Press the button.

If you feel slightly warm:

Press the button to lower the temperature.

One press lowers the temperature by about 1°C.

If you feel slightly cool:

Press the button to raise the temperature.

One press raises the temperature by about 1°C.

When “I FEEL...” is not selected, press the button until it is set.

Each time the button is pressed, the operation mode is changed in sequence: (I FEEL...) → (AUTO) → (COOL) → (DRY) → (HEAT)

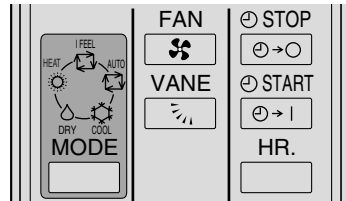

Description of “AUTO RESTART FUNCTION”

- These units are equipped with an auto restart function. When the main power is turned on, the air conditioner will start operation automatically in the same mode as the one set with the remote controller before the shutoff of the main power.
- If the unit was set to off with the remote controller before the shutoff of the main power, it will remain stopped even after the main power is turned on.
- If the unit was in the emergency operation before the shutoff of the main power, it will start operation, when main power comes on, in the same mode as the one set with the remote controller before the emergency operation.
- If the unit is operated in “I FEEL...” or “AUTO” mode before power failure, the operation mode (COOL, DRY or HEAT) is not stored in the memory. When the main power is turned on, the unit decides the operation mode by the initial room temperature at restart and starts operation again.

Description of “I FEEL...” mode

Details of operation

According to the room temperature when the operation starts, the operation mode is automatically set to COOL, DRY or HEAT. However, when operation is started again within 2 hours after it is stopped, the same operation mode before the operation is stopped is selected. The operation mode selected first is not changed even if the room temperature changes. If the operation mode does not match the room condition, select the appropriate operation mode by pressing the button.

Details of auto operation

Room temperature when started	Operation mode	Target temperature (initial state)
About 25°C or higher	COOL	About 24°C
About 25°C to 23°C	DRY	—
About 23°C or lower	HEAT	About 26°C

NOTE:

COOL: When the room temperature is 2°C higher than the set temperature, the set temperature may not be changed since the air conditioner is operating to reach the target (set) temperature. In this case, please wait until the room temperature drops to within 2°C of the set temperature and then change the set temperature.

HEAT: When the room temperature is 2°C lower than the set temperature, the set temperature may not be changed since the air conditioner is operating to reach the target (set) temperature. In this case, please wait until the room temperature rises to within 2°C of the set temperature and then change the set temperature.

Details of display on the indoor unit

The operation indicator at the right side of the indoor unit indicates the operation state.

Operation Indicator Lighted
 Not lighted

Operation indicator lamp

Indication	Operation state	Difference between target temperature and room temperature
	This shows that the air conditioner is operating to reach the target temperature. Please wait until the target temperature is obtained.	About 2°C or more
	This shows that the room temperature is approaching the target temperature.	About 2°C or less

AUTO CHANGEOVER... AUTO MODE OPERATION

An automatic cooling and heating changeover operation system ensures easy control and year-round air conditioning.

Once the desired temperature is set, unit operation is switched automatically between cooling and heating according to the room temperature. In addition, fan control of the outdoor unit enables cooling operation at outside temperature as low as -10 °C.

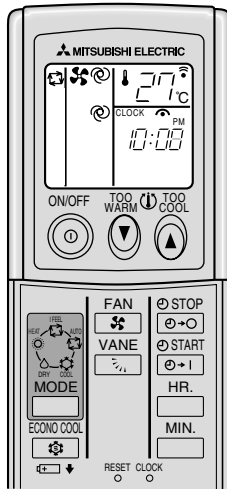

To select the AUTO mode:

- 1 Press the button.
- 2 Select the (AUTO) mode by pressing the button.

Each time this button is pressed, the operation mode is changed in sequence:
 (I FEEL...) → (AUTO) → (COOL) → (DRY) → (HEAT)
 The set temperature is also displayed on the remote controller.

To stop operation:

- 1 Press the button.
- After the operation mode is set once, the operation starts in the same mode as the one set previously from the next time by simply pressing the button.

When the set temperature is to be changed:

- Press the button to lower the temperature. One press lowers the temperature by about 1°C.
- Press the button to raise the temperature. One press raises the temperature by about 1°C.

Description of “AUTO CHANGEOVER”

(1) Initial mode

- ① When unit starts the operation with AUTO operation from off;
 - If the room temperature is higher than the set temperature, operation starts in COOL mode.
 - If the room temperature is equal to or lower than the set temperature, operation starts in HEAT mode.

(2) Mode change

- ① COOL mode changes to HEAT mode when 15 minutes have passed with the room temperature 2 degrees below the set temperature.
- ② HEAT mode changes to COOL mode when 15 minutes have passed with the room temperature 2 degrees above the set temperature.

Description of “AUTO RESTART FUNCTION”

Refer to page 6.

MANUAL OPERATION (COOL, DRY, HEAT)

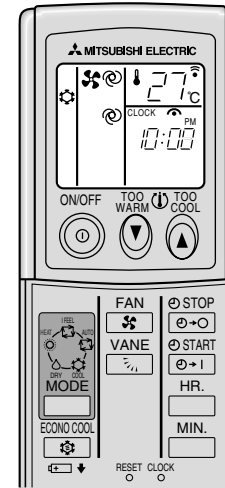

To select the COOL, DRY or HEAT mode:

- 1 Press the button.
- 2 Select the operation mode by pressing the button.

Each time this button is pressed, the operation mode is changed in sequence:
 (I FEEL...) → (AUTO) → (COOL) → (DRY) → (HEAT)

To stop operation:

- 1 Press the button.
- After the operation mode is set once, the operation starts in the same mode as the one set previously from the next time by simply pressing the button.

When the set temperature is to be changed:

- Press the button to lower the temperature. One press lowers the temperature by about 1°C.
- Press the button to raise the temperature. One press raises the temperature by about 1°C.

In COOL operation

- When the outside temperature is low, the fan of the outdoor unit turns on and off frequently to maintain sufficient cooling capacity.

In DRY operation

- The temperature control (temperature setting) cannot be done.
- The room temperature is slightly lowered in this operation mode.

The details of the display on the indoor unit are explained on page 6.

NOTE:

When the ambient temperature is too high, the room temperature may not reach the set temperature since the unit operates to cool the room under a high load.

Description of “AUTO RESTART FUNCTION”

Refer to page 6.

AIR FLOW VELOCITY AND DIRECTION ADJUSTMENT

AIR FLOW velocity and direction can be selected as required.

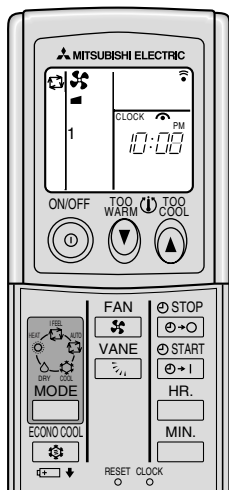



To change the AIR FLOW velocity, press the button.

Each time the button is pressed, the fan speed is changed in sequence:
 ■ (Low) → ■■ (Med.) → ■■■ (High) →  (AUTO)

- Use the ■■■ (High) notch to cool/heat the room more.
- If the operating sound of the air conditioner disturbs your sleep, use the ■ (Low) notch.

To change the AIR FLOW blowing direction vertically, press the button.

Each time the button is pressed, the angle of the horizontal vane is changed in sequence: 1 → 2 → 3 → 4 → 5 →  (SWING) →  (AUTO)

SWING OPERATION
 Use the swing operation for the air flow to reach all corners of the room.

Recommended horizontal vane range
 Use the  (AUTO) position usually.
 Use position 1 or 2 in the COOL or DRY mode and use positions 3 to 5 in the HEAT mode when adjusting to your requirements.

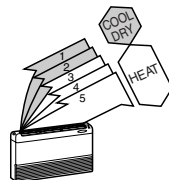

- NOTE:**
- In the cooling operation, when the air conditioner is operated with setting the horizontal vane to 4 or 5 for 1 hour, the AIR FLOW direction is automatically set to horizontal to prevent condensed water from dropping.
 - Adjust the vertical AIR FLOW direction using the remote controller. If the horizontal vane is moved manually, it may cause trouble.
 - In the heating operation, if the air flow temperature is too low or when defrosting is being done, the horizontal vane position is set to position 1.

To change the horizontal direction of the AIR FLOW

For the floor standing unit

- Change the direction of the vertical vane manually.

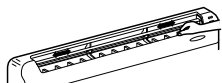

For the ceiling suspended unit

- Change the direction of the vertical vane manually.

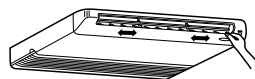

Adjust the vane before operation starts.
 Since the horizontal vane moves automatically, your fingers may be caught.

AUTO AIR FLOW DIRECTION CONTROL OPERATION

When the AUTO mode is selected with the  button, the position of the horizontal vane is automatically set to correspond to the operation mode for effective operation.

For the floor standing unit

(1) COOL, DRY

- The air is blown out upwards.

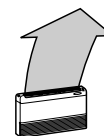

(2) HEAT

- When the air flow temperature is too low, the air is blown out upwards.
- When the air flow temperature rises, the air is blown out horizontally.

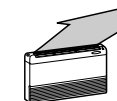

For the ceiling suspended unit

(1) COOL, DRY

- The air is blown out horizontally.

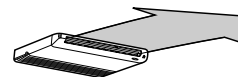

(2) HEAT

- When the air flow temperature is too low, the air is blown out horizontally.
- When the air flow temperature rises, the air is blown out downwards.

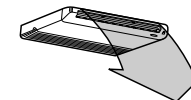
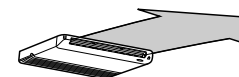

- NOTE:**
- When the operation mode changes in " (AUTO)" mode, the horizontal vane is automatically changed to the position in each mode.

ECONO COOL OPERATION

Use this operation when you want to be comfortable in COOL mode even with energy saved.

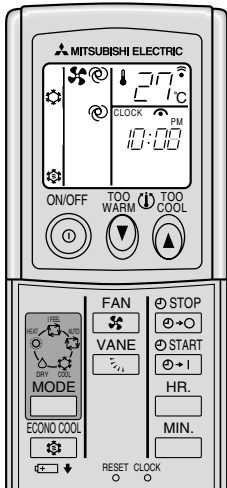

Perform the following operations while the unit is operating in the MANUAL COOL mode.

Press the button.

When the (ECONO COOL) operation is selected in COOL mode, the air conditioner performs swing operation in various cycle according to the temperature of air conditioner. Also SET TEMPERATURE is automatically set 2°C higher than in COOL mode.

To release the ECONO COOL operation:

Press the button again.

- When the button is pressed or the operation mode is changed during the ECONO COOL operation, ECONO COOL operation is released.
- The , the or button and ON/OFF timer (explained below) are available.

What is "ECONO COOL"?

Swing air flow (change of air flow) makes you feel cooler than constant air flow. So, even though the set temperature is automatically set 2°C higher, it is possible to perform cooling operation with keeping comfort. As a result, energy can be saved.

TIMER OPERATION (ON/OFF TIMER)

It is convenient to set the timer when you go to bed, when you get home, when you get up, etc.

How to set the ON timer

1 Press the button during operation.

Each time the button is pressed, the ON timer mode alternates between ON and OFF.

2 Set the time of the timer using the and buttons.

Each time the button is pressed, the set time increases by 1 hour; each time the button is pressed, the set time increases by 10 minutes.

To release the ON timer:

Press the button.

How to set the OFF timer

1 Press the button during operation.

Each time the button is pressed, the OFF timer mode alternates between ON and OFF.

2 Set the time of the timer using the and buttons.

Each time the button is pressed, the set time increases by 1 hour; each time the button is pressed, the set time increases by 10 minutes.

To release the OFF timer:

Press the button.

Programming timer operation

The ON timer and the OFF timer can be used in combination. The timer of the set time that is reached first will operate first. ("1" mark indicates the order of timer operations.)

- If the current time has not been set, the timer operation cannot be used.

NOTE:

If the main power is turned off or a power failure occurs while AUTO START/STOP timer is active, the timer setting is cancelled. As these models are equipped with an auto restart function, the air conditioner starts operating with timer cancelled at the same time that power is restored.

WHEN THE AIR CONDITIONER IS NOT GOING TO BE USED FOR A LONG TIME

When it is not going to be used for a long time:

1 Perform the FAN operation for 3 or 4 hours to dry the inside of the air conditioner.

- To perform FAN operation, set the remote controller to the highest temperature in the MANUAL COOL mode. (Refer to page 7.)

2 Turn off the breaker and/or disconnect the power supply plug.



CAUTION:

Turn off the breaker and/or disconnect the power supply plug when the air conditioner is not going to be used for a long time.

Dirt may collect and this may cause a fire.

3 Remove the batteries from the remote controller.

CAUTION:

To prevent liquid leakage, take out all batteries when the remote controller is not going to be used for a long time.

When the air conditioner is to be used again:

1 Clean the air filter and install it in the indoor unit.

(Refer to page 10 for cleaning instructions.)

2 Check that the air inlet and outlet of the indoor/outdoor units are not blocked with any obstacles.

3 Check that the earth is connected correctly.

CAUTION:

Earth the unit.

Do not connect the earth to a gas pipe, water pipe, lightning rod or the earth of a telephone. If the earthing is incorrect, it may cause an electric shock.

MAINTENANCE

Before starting maintenance

Turn off the breaker and/or disconnect the power supply plug.



CAUTION:

When the unit is to be cleaned, switch it off and disconnect the power supply plug and/or turn off the breaker. Since the fan rotates at high speed during operation, it may cause an injury.

Cleaning the indoor unit

Clean the unit using a soft dry cloth.

- If the dirt is noticeable, wipe the unit with a cloth soaked in a solution of mild detergent diluted in lukewarm water.
- Do not use gasoline, benzene, polishing powder, or insecticide. The unit may be damaged.

CLEANING THE AIR FILTER/THE DEODORIZING FILTER (OPTION)

Cleaning the air filter (about once every 2 weeks)

1 Remove the air filter.

- Pull the air inlet knob forward.

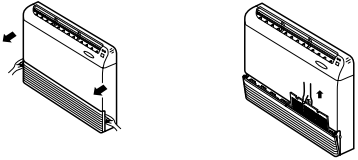

(If there is deodorizing or air cleaning filter (OPTION), please remove it before cleaning the air filter.)

2 Remove dirt from the air filter using a vacuum cleaner or by washing the filter with water.

- If the dirt is noticeable, wash the filter with a solution of mild detergent diluted in lukewarm water.
- If hot water (50°C or more) is used, the filter may be deformed.

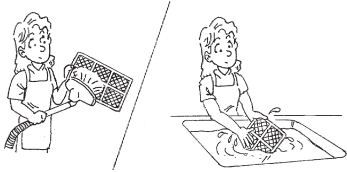

3 After washing with water/lukewarm water, dry the air filter well in the shade.

- Do not expose the air filter to direct sunlight or heat from a fire when drying it.

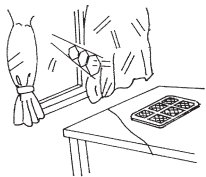

4 Install the air filter.

- Set the air inlet knob.

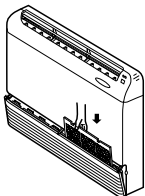

Cleaning the deodorizing filter (about once every 2 weeks)

1 Remove the air filter and the deodorizing filter together. Then separate the deodorizing filter (Gray sponge type) from the air filter.

- The deodorizing filter is harmless to people. However, to keep its effectiveness, be sure to hold the frame and not to touch the surface of the filter with your hand.

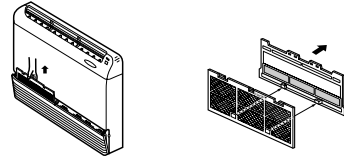

2 Soak the filter together with its frame in lukewarm water for about 15 minutes.

- If the dirt is noticeable, use a solution of mild detergent diluted in lukewarm water.
- If hot water (50°C or more) is used, the filter may be deformed.
- Do not use a scrubbing brush or sponge. This may damage the surface of the filter.
- Do not use a chlorine detergent.

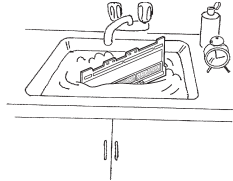

3 After washing with water/lukewarm water, dry the deodorizing filter well in the shade.

- Do not expose the deodorizing filter to direct sunlight or heat from a fire when drying it.

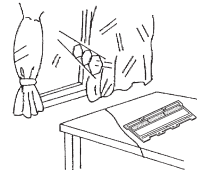

4 Attach the deodorizing filter to the air filter. (Place the catch into the hole of the air filter for the security.) Then install both of them to the body.

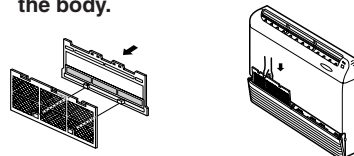

REPLACEMENT OF THE DEODORIZING FILTER (OPTION)/AIR CLEANING FILTER (OPTION)

When the capacity is lowered because of dirt, etc., it is necessary to replace the deodorizing filter/air cleaning filter.

Deodorizing filter replacement (about once a year)

1 Remove the air filter and the deodorizing filter together.

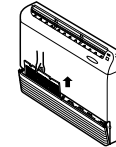

2 Separate the deodorizing filter (Gray sponge type) from the air filter.

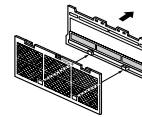

3 Replace a new deodorizing filter and attach it to the air filter. (Place the catch into the hole of the air filter for the security.)

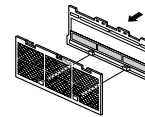

4 Install the air filter and the deodorizing filter together.

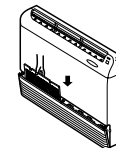

Deodorizing filter

- Cleaning is necessary about once every 2 weeks. However, if the dirt is noticeable, clean more often.
- When the colour of the filter is not restored even if the filter is washed as the procedure shown on the left (Cleaning the deodorizing filter) or when the filter becomes black, replace the filter with a new one.
- Standard interval for filter replacement is about 1 year.

Optional parts Optional parts are available from your local dealer.

Name of parts	DEODORIZING FILTER	AIR CLEANING FILTER
Parts number	MAC-1700DF	MAC-1200FT

Air cleaning filter replacement (about once every 4 months)

1 Remove the air filter and the air cleaning filter together.

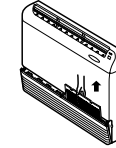

2 Separate the air cleaning filter (White bellows type) from the air filter.

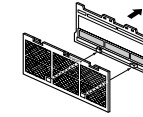

3 Replace a new air cleaning filter and attach it to the air filter. (Place the catch into the hole of the air filter for the security.)

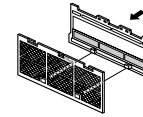

4 Install the air filter and the air cleaning filter together.

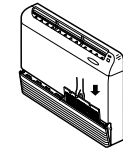

Air cleaning filter

- If the air cleaning filter is clogged, it may lower the unit's capacity or cause condensation at the air outlet.
- The air cleaning filter is disposable. The standard usable term is about 4 months. However, if the colour of the filter turns to dark brown, replace the filter at once.

BEFORE CONTACTING THE SERVICE REPRESENTATIVE, CHECK THE FOLLOWING AGAIN

Question	Check points
The air conditioner cannot be operated.	<ul style="list-style-type: none"> Is the breaker turned on? Is the fuse blown? Is the ON timer set? (Page 9)
The room cannot be cooled or heated sufficiently.	<ul style="list-style-type: none"> Is the temperature setting correct? (Page 7) Is the filter clean? (Page 10) Are there any obstacles blocking the air inlet or outlet of the indoor or outdoor unit? Is a window or door open?
The air from the indoor unit smells strange.	<ul style="list-style-type: none"> Is the filter clean? (Page 10)
The display on the remote controller does not appear or it is dim. The indoor unit does not respond to the remote control signal.	<ul style="list-style-type: none"> Are the batteries exhausted? (Page 5) Is the polarity (+, -) of the batteries correct? (Page 5) Are any buttons on the remote controller of other electric appliances being pressed?
When a power failure occurs.	<ul style="list-style-type: none"> Does the air conditioner start operating again? If the air conditioner had operated before the power failure, as these models are equipped with an auto restart function, the air conditioner should start operating again. (Refer to Description of "AUTO RESTART FUNCTION" on page 6.)

Even if the above items are checked, when the air conditioner does not recover from the trouble, stop using the air conditioner and consult your dealer.

In the following cases, stop using the air conditioner and consult your dealer.

- When water leaks or drops from the indoor unit.
- When the left operation indicator lamp blinks.
- When the breaker trips frequently.
- The remote control signal may not be received in a room where an electronic ON/OFF type fluorescent lamp (inverter-type fluorescent lamp, etc.) is used.
- Operation of the air conditioner may interfere with radio or TV reception in areas where the reception is weak. An amplifier may be required for the affected device.
- When thunder is heard, stop operation and disconnect the power supply plug and/or turn off the breaker. Otherwise, the electrical parts may be damaged.

WHEN YOU THINK THAT TROUBLE HAS OCCURRED

Question	Answer (not a malfunction)
The air conditioner cannot be operated for about 3 minutes when restarted.	<ul style="list-style-type: none"> This protects the air conditioner according to instructions from the microprocessor. Please wait.
Cracking sound is heard.	<ul style="list-style-type: none"> This sound is generated by the expansion/contraction of the front panel, etc. due to change in temperature.
The air from the indoor unit smells strange.	<ul style="list-style-type: none"> The air conditioner may suck in an odor adhering to the wall, carpet, furniture, cloth, etc. and blow it out with the air.
The fan of the outdoor unit does not rotate even though the compressor is running. Even if the fan starts to rotate, it stops soon.	<ul style="list-style-type: none"> When the outside temperature is low, the fan may not operate to maintain sufficient cooling capacity.
The sound of water flowing is heard.	<ul style="list-style-type: none"> This is the sound of refrigerant flowing inside the air conditioner. This is the sound of condensed water flowing in the heat exchanger. This is the sound of the heat exchanger defrosting.
The sound as burbling is heard.	<ul style="list-style-type: none"> This sound is heard when the outside air is absorbed from the drain hose in turning on the range hood or the ventilation fan and that makes water flowing in the drain hose spout out. This sound is also heard when the outside air blows into the drain hose in case the outside wind is strong.
The room cannot be cooled sufficiently.	<ul style="list-style-type: none"> When a ventilation fan or a gas cooker is used in a room, the cooling load increases, resulting in an insufficient cooling effect. When the outside temperature is high, the cooling effect may not be sufficient.
Mist is discharged from the air outlet of the indoor unit.	<ul style="list-style-type: none"> The cool air from the air conditioner rapidly cools moisture in the air inside the room, and it turns into mist.
Mechanical sound is heard from the indoor unit.	<ul style="list-style-type: none"> This is the switching sound in turning on/off the fan or the compressor.

Question	Answer (not a malfunction)
The air flow direction changes during operation. The direction of the horizontal vane cannot be adjusted with the remote controller.	<ul style="list-style-type: none"> When the air conditioner is operated in COOL or DRY mode, if the operation continues with air blowing down for 1 hour, the direction of the air flow is automatically set to position 1 to prevent condensed water from dropping. In the heating operation, if the air flow temperature is too low or when defrosting is being done, the horizontal vane position is automatically set to position 1.
Water leaks from the outdoor unit.	<ul style="list-style-type: none"> During COOL and DRY operations, pipe or pipe connecting sections are cooled and this causes water to condense. In the heating operation, the defrosting operation makes water frozen on the outdoor unit melt and drip down. In the heating operation, water condensed on the heat exchanger drips down.
White smoke is discharged from the outdoor unit.	<ul style="list-style-type: none"> In the heating operation, vapor generated by the defrosting operation looks like white smoke.
Air does not blow out soon in the heating operation.	<ul style="list-style-type: none"> Please wait as the air conditioner is preparing to blow out warm air.
The operation is stopped for about 10 minutes in the heating operation.	<ul style="list-style-type: none"> Defrosting of the outdoor unit is being done (Defrosting operation). Since this is completed in 10 minutes, please wait. (When the external temperature is too low and humidity is too high, frost is formed.)
Hissing sound is sometimes heard.	<ul style="list-style-type: none"> This is the sound when the flow of refrigerant inside the air conditioner is switched.
The room cannot be heated sufficiently.	<ul style="list-style-type: none"> When the outside temperature is low, the heating effect may not be sufficient.
The air conditioner starts the operation only with the main power turned on, though you do not operate the unit with the remote controller.	<ul style="list-style-type: none"> These models are equipped with an auto restart function. When the main power is turned off without stopping the air conditioner with the remote controller and is turned on again, the air conditioner will start operation automatically in the same mode as the one set with the remote controller just before the shutoff of the main power.

This product is designed and intended for use in the residential, commercial and light-industrial environment.

The product at hand is based on the following EU regulations:

- Low Voltage Directive 73/23/ EEC
- Electromagnetic Compatibility Directive 89/336/ EEC

 **MITSUBISHI ELECTRIC CORPORATION**
HEAD OFFICE: MITSUBISHI DENKI BLDG., 2-2-3, MARUNOUCHI, CHIYODA-KU, TOKYO 100-8310, JAPAN

VN79A517H01

This pdf has been downloaded from the website of :

“Supplying and installing the latest in air conditioning technology”

° Celsius
air conditioning

Celsius Air Conditioning Ltd, 1 Well Street, Heywood, Greater Manchester OL10 1NT

 01706 367 500  07000 CELSIUS  01706 367 355  sales@celsiusair.co.uk  www.celsiusair.co.uk

www.celsiusair.co.uk