

Air-Conditioners

Indoor unit

PCA-RP·GA
PKA-RP·FAL
PKA-RP·GAL

Outdoor unit

PUHZ-RP·HA
PU(H)-P·GAA

OPERATION MANUAL

FOR USER

For safe and correct use, please read this operation manual thoroughly before operating the air-conditioner unit.

BEDIENUNGSHANDBUCH

FÜR BENUTZER

Zum sicheren und einwandfreien Gebrauch der Klimaanlage dieses Bedienungshandbuch vor Inbetriebnahme gründlich durchlesen.

MANUEL D'UTILISATION

POUR L'UTILISATEUR

Pour une utilisation correcte sans risques, veuillez lire le manuel d'utilisation en entier avant de vous servir du climatiseur.

BEDIENINGSHANDLEIDING

VOOR DE GEBRUIKER

Voor een veilig en juist gebruik moet u deze bedieningshandleiding grondig doorlezen voordat u de airconditioner gebruikt.

MANUAL DE INSTRUCCIONES

PARA EL USUARIO

Lea este manual de instrucciones hasta el final antes de poner en marcha la unidad de aire acondicionado para garantizar un uso seguro y correcto.

ISTRUZIONI DI FUNZIONAMENTO

PER L'UTENTE

Leggere attentamente questi istruzioni di funzionamento prima di avviare l'unità, per un uso corretto e sicuro della stessa.

ΕΓΧΕΙΡΙΔΙΟ ΟΔΗΓΙΩΝ ΧΡΗΣΕΩΣ

ΓΙΑ ΤΟΝ ΧΡΗΣΤΗ

Για ασφάλεια και σωστή χρήση, παρακαλείστε διαβάσετε προσεκτικά αυτό το εγχειρίδιο χρήσεως πριν θέσετε σε λειτουργία τη μονάδα κλιματισμού.

MANUAL DE OPERAÇÃO

PARA O UTILIZADOR

Para segurança e utilização correctas, leia atentamente o manual de operação antes de pôr a funcionar a unidade de ar condicionado.

DRIFTSMANUAL

TIL BRUGER

Læs venligst denne driftsmanual grundigt før airconditionanlægget betjenes af hensyn til sikker og korrekt brug.

DRIFTSMANUAL

FÖR ANVÄNDAREN

Läs denna driftsmanual noga för säkert och korrekt bruk innan luftkonditioneringen används.

İşletme Elkitabı

KULLANICI İÇİN

Emniyetli ve doğru biçimde nasıl kullanılacağını öğrenmek için lütfen klima cihazını işletmeden önce bu elkitabını dikkatle okuyunuz.

РУКОВОДСТВО ПО ЭКСПЛУАТАЦИИ

ДЛЯ ПОЛЬЗОВАТЕЛЯ

Для обеспечения правильного и безопасного использования следует ознакомиться с инструкциями, указанными в данном руководстве по эксплуатации, тщательным образом до того, как приступить к использованию кондиционера.

操作说明书

用户适用 (安装人员适用)

在操作空调机之前，请全面阅读本操作说明书，以便安全和正确地使用本机。

English

Deutsch

Français

Nederlands

Español

Italiano

Ελληνικά

Português

Dansk

Svenska

Türkçe

Русский

中文

Contents

1. Safety Precautions	2
2. Operation	3
3. Care and cleaning	5
4. Troubleshooting	7
5. Specifications	8

1. Safety Precautions

- ▶ Before installing the unit, make sure you read all the “Safety precautions”.
- ▶ The “Safety precautions” provide very important points regarding safety. Make sure you follow them.
- ▶ Please report to or take consent by the supply authority before connection to the system.

Symbols used in the text









⚠ Warning:

Describes precautions that should be observed to prevent danger of injury or death to the user.

⚠ Caution:

Describes precautions that should be observed to prevent damage to the unit.

Symbols used in the illustrations

-  : Indicates an action that must be avoided.
-  : Indicates that important instructions must be followed.
-  : Indicates a part which must be grounded.
-  : Indicates that caution should be taken with rotating parts.
-  : Indicates that the main switch must be turned off before servicing.
-  : Beware of electric shock.
-  : Beware of hot surface.
-  : At servicing, please shut down the power supply for both of Indoor Unit and Outdoor Unit.

⚠ Warning:

Carefully read the labels affixed to the main unit.

⚠ Warning:

- The unit should not be installed by the user. Ask the dealer or an authorized company to install the unit. If the unit is installed improperly, water leakage, electric shock or fire may result.
- Do not stand on, or place any items on the unit.
- Do not splash water over the unit and do not touch the unit with wet hands. An electric shock may result.
- Do not spray combustible gas close to the unit. Fire may result.
- Do not place a gas heater or any other open-flame appliance where it will be exposed to the air discharged from the unit. Incomplete combustion may result.
- Do not remove the front panel or the fan guard from the outdoor unit when it is running.
- When you notice exceptionally abnormal noise or vibration, stop operation, turn off the power switch, and contact your dealer.
- Never insert fingers, sticks etc. into the intakes or outlets.
- If you detect odd smells, stop using the unit, turn off the power switch and consult your dealer. Otherwise, a breakdown, electric shock or fire may result.
- This air conditioner is NOT intended for use by children or infirm persons without supervision.
- Young children should be supervised to ensure that they do not play with the air conditioner.
- If the refrigeration gas blows out or leaks, stop the operation of the air conditioner, thoroughly ventilate the room, and contact your dealer.

⚠ Caution:

- Do not use any sharp object to push the buttons, as this may damage the remote controller.
- Never block or cover the indoor or outdoor unit's intakes or outlets.

Disposing of the unit

When you need to dispose of the unit, consult your dealer.

2. Operation

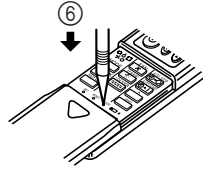
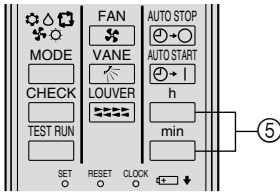
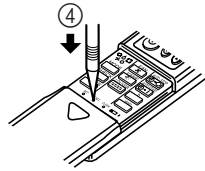
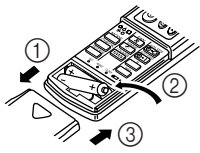

Replacing the Batteries and how to set the current time

If no signal is transmitted and the indoor unit's lamp does not light up even if the remote controller is operated, the batteries may have run out, so replace them with new ones as described below.

- ① Remove the front lid.
- ② Replace the batteries with alkali batteries (size AAA). Make sure that the batteries are installed in the correct direction. (Insert the minus pole of the batteries first.)
- ③ Reattach the front lid.
- ④ Press the RESET button using a thin stick.
- ⑤ Press the **h** and **min** button to set the current time.
- ⑥ Press the CLOCK button using a thin stick and close the front lid.

If you are not going to use the unit for a long period of time, remove the batteries to prevent damage which may occur due to leakage of electrolyte.

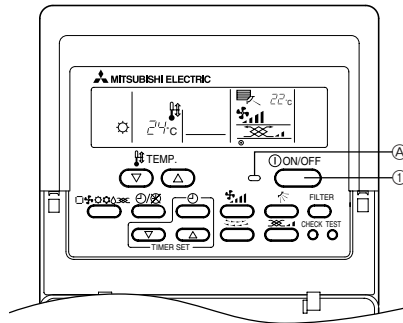
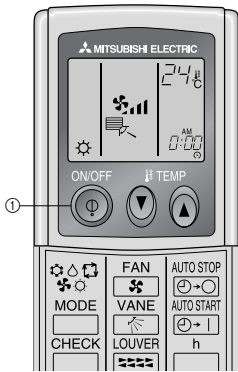

Check if your remote controller is the wired type or the wireless type before referring to the illustration and text for operation procedures.

2.1. Switching the unit on/off

The power supply should not be turned off while the air conditioner is in use. This can cause the unit to break down.

- ① Press the ON/OFF button.

(A) The ON indicator should light up.

- Even if you press the ON/OFF button immediately after shutting down the operation in progress, the air conditioner will not start for about three minutes. This is to prevent the internal components from being damaged.
- If the operation stops due to a power failure, the unit will not automatically restart until the power has been restored. Press the ON/OFF button to restart.

2.2. Mode select

- ① If the unit is off, press the ON/OFF button to turn it on.

(A) The ON indicator should light up.

- ② Press the operation mode () button and select the operation mode.

(B)

Cooling mode

Fan mode

Heating mode

Drying mode

Automatic (cooling/heating) mode

Note:

The heating display and the automatic display does not appear in models that operate exclusively as cooling only air-conditioner.

2.3. Selecting a temperature

► To decrease the room temperature:

- ① Press button to set the desired temperature.

(A) The selected temperature is displayed.

- Each time you press the button, the temperature value decreases by 1 °C.

► To increase the room temperature:

- ① Press button to set the desired temperature.

(A) The selected temperature is displayed.

- Each time you press the button, the temperature value increases by 1 °C.

- Available temperature ranges are as follows:

Cooling & Drying: 19 - 30 °C

Heating: 17 - 28 °C

Automatic: 19 - 28 °C

Circulation: — (Not available)

- The display flashes either 8 °C - 39 °C to inform you if the room temperature is lower or higher than the displayed temperature.

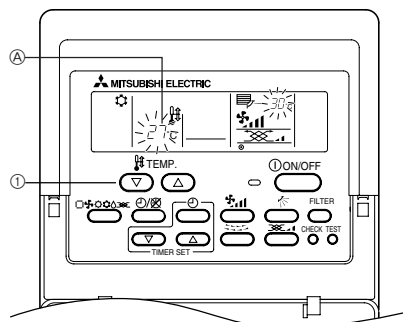
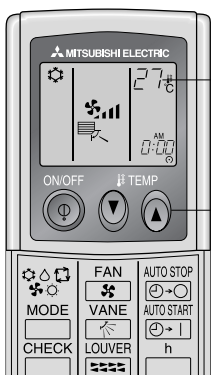
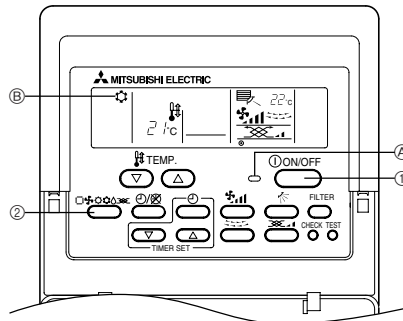
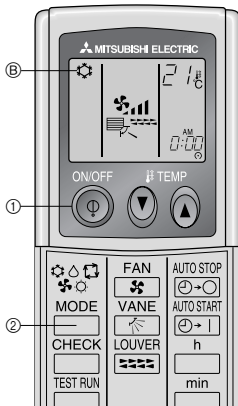



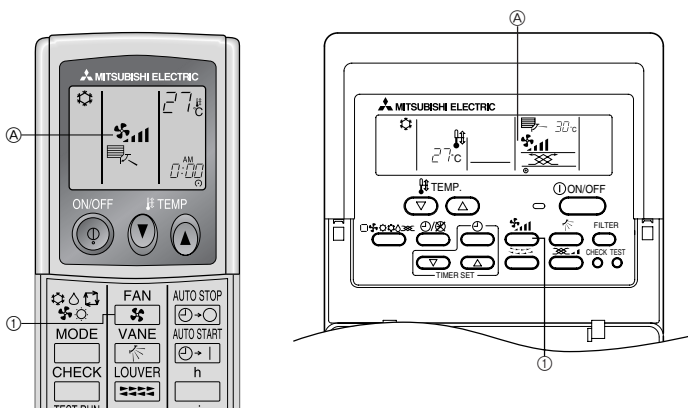

2. Operation



2.4. Selecting a fan speed

- Press  button to select a desired fan speed.
- Each time you press the button, available options change with the display **A** on the remote controller, as shown below.

Fan speed	Remote controller display			
	Low	Middle 2*	Middle 1*	High
4-stage				

The display and the fan speed of the unit will differ in the following situations:

- When STAND BY and DEFROST are displayed.
- Just after the heating mode (while waiting to change to another mode).
- When the temperature of the room is higher than the temperature setting of the unit operating in the heating mode.
- In the dry operation, the indoor fan automatically turns to low-speed operation. Switching of fan speed is impossible.

* Not for PKA-RP-FAL.

2.5. Adjusting vertical airflow direction

■ Except for PSA/PSH series

The vertical air vane helps select the vertical direction of the airflow.

- Press  button to select the vertical airflow direction.
- Each time you press the button, the option changes are displayed on the remote controller, as shown below.

A (swing) → **B** → **C** → **D** → **E** → **A**



- If the room temperature is higher than the temperature set on the remote controller while the unit is defrosting or preparing for heating, the vertical air vane will move to the horizontal airflow position (**B**).
- In either cooling or dry mode, if you select **C**, **D** or **E** when the fan speed is low, middle 2, a display reading "1 Hr" **F** will appear. After one hour, the air conditioner will switch automatically to horizontal air mode **B** and the display "1 Hr" **F** will disappear.
- When the heating thermostat is OFF, the louver automatically turns horizontally during defrosting or preparation for heating.

2.6. Using the timer

1) Set the current time

- Press  button to display the "CLOCK" **B**.



Remote controller display A	CLOCK →  ON →  OFF → No Display
------------------------------------	---

- Each time you press  button, the time increases in increments of one minute. Each time you press  button, the time decreases in increments of one minute.
 - Press and hold the button to rapidly change the time.
 - The time changes in increments of one minute → ten minutes → in units of hour; in this order.
 - Approximately ten seconds after pressing the button, the display on the remote controller will turn off.
- The example shows a timer set for operation start at 8:00 and end at 17:00.



2) Set the mode to continuous as follows

- Press  button to display **D** .

3) Set the time to start the unit as follows

- Press  button to display **B** .
- Press  button to set the time that you want the unit to start. The start time is displayed at **A**.

4) Set the time to stop the unit as follows

- Press  button to display **C** .
- Press  button to set the time that you want the unit to stop. The stop time is displayed at **A**.

5) Set the mode to timer as follows

- Press  button to display **D** .

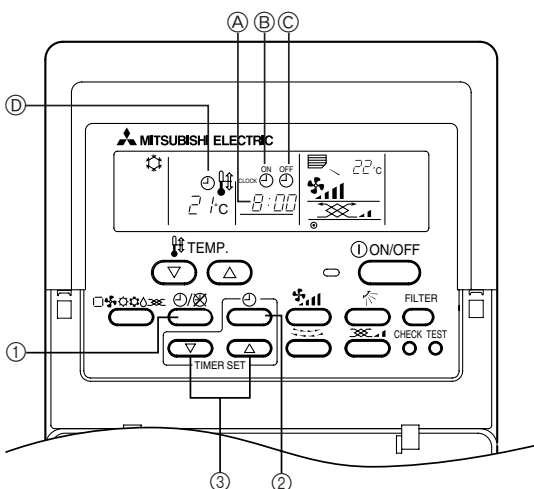
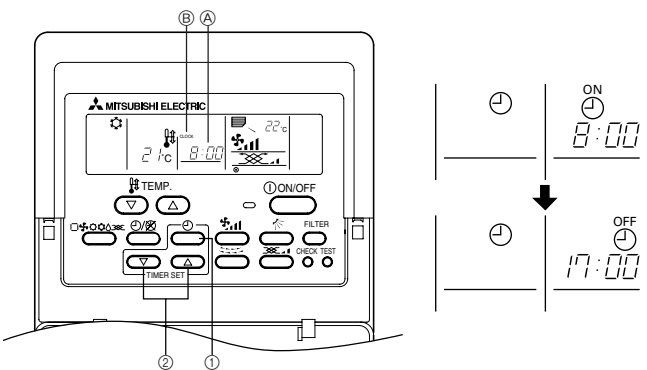
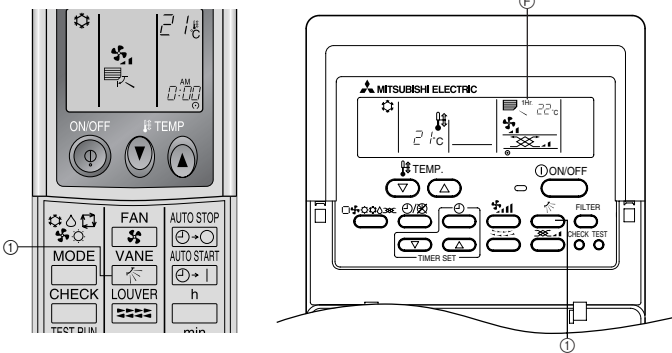
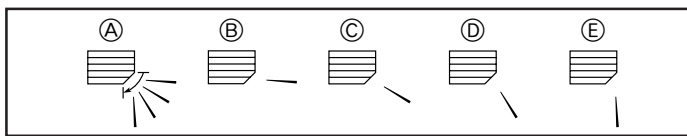

2. Operation

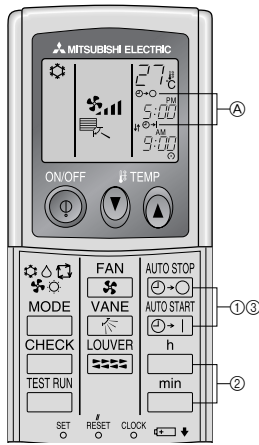

For wireless remote controller

- ① Press the or button (TIMER SET).
- Time can be set while the following symbol is blinking.
OFF timer : is blinking.
ON timer : is blinking.
- ② Use the and buttons to set the desired time.
- ③ Canceling the timer.
To cancel the OFF timer, press the .
- To cancel the ON timer, press the .

- It is possible to combine both OFF and ON timers.
- Pressing the ① ON/OFF button of the remote controller during timer mode to stop the unit will cancel the timers.
- If the current time has not been set, the timer operation cannot be used.

3. Care and cleaning

■ PKA-RP-GAL

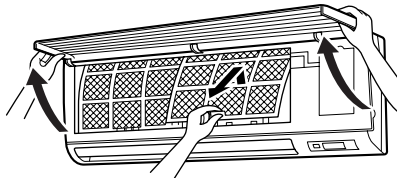
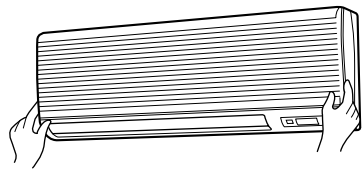

■ PKA-RP-FAL

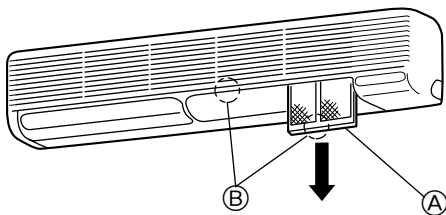

■ PCA-RP-GA

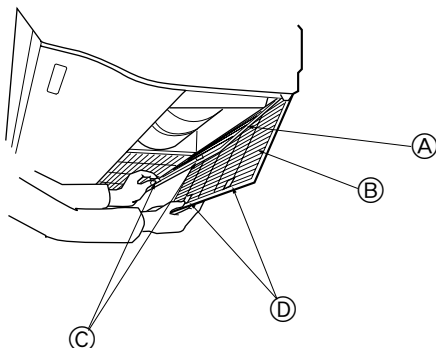

3.1. Cleaning the filters and the indoor unit

Cleaning the filters

- Clean the filters using a vacuum cleaner. If you do not have a vacuum cleaner, tap the filters against a solid object to knock off dirt and dust.
- If the filters are especially dirty, wash them in lukewarm water. Take care to rinse off any detergent thoroughly and allow the filters to dry completely before putting them back into the unit.

⚠ Caution:

- Do not dry the filters in direct sunlight or by using a heat source, such as an electric heater: this may warp them.
- Do not wash the filters in hot water (above 50°C), as this may warp them.
- Make sure that the air filters are always installed. Operating the unit without air filters can cause malfunction.

⚠ Caution:

- Before you start cleaning, stop operation and turn OFF the power supply.
- Indoor units are equipped with filters to remove the dust of sucked-in air. Clean the filters using the methods shown in the following sketches.

Filter removal

⚠ Caution:

- In removing the filter, precautions must be taken to protect your eyes from dust. Also, if you have to climb up on a stool to do the job, be careful not to fall.
- When the filter is removed, do not touch the metallic parts inside the indoor unit, otherwise injury may result.

■ PKA-RP-GAL

- ① Pull both the bottom corners of the intake grille to open the grille, then lift the filter.

■ PKA-RP-FAL

- ① Hold the filter lug (located at the bottom of the intake grille) and pull it out downward.

Ⓐ Filter

Ⓑ Lug

- To reinstall the filters, push the filter lug upward.

■ PCA-RP-GA

- ① Open the intake grille.

- ② Hold the knob on the filter then pull the filter up in the direction of an arrow. To replace the filter after cleaning, be sure to insert the filter far enough until it fits into the stopper.

Ⓐ Filter

Ⓑ Intake Grille

Ⓒ Knob

Ⓓ Stopper

3. Care and cleaning

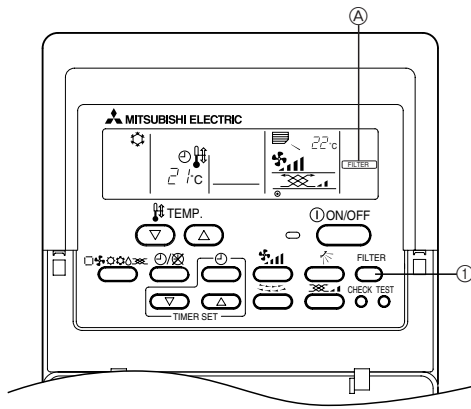

3.2. Care and cleaning

Clean the filter

When the **A** "FILTER" indicator blinks on the remote controller to alert you to the necessity of cleaning of the filter.

* As a guideline for typical office environment, the filter must be cleaned every 100 operating hours.

Reset the FILTER indicator

① Press the FILTER button twice after cleaning.

► When you press the FILTER button twice, the "FILTER" indicator **A** will be turned off and reset.

► The FILTER indicator provides you with a guideline for the necessity of filter cleaning based on total operating hours in typical indoor air conditions. Depending on different operating environments, more or less frequent cleaning may be necessary.

4. Troubleshooting

Before you call out a repair man, check the following table to see whether there is a simple solution to your problem.

[for wireless remote controller]

Problem	Solution	Problem	Solution
Unit does not operate at all.	Turn main power on. Then press the POWER ON/OFF button to turn the unit on. Wait until power is restored, then press the POWER ON/OFF button to turn the unit on.	Unit does not start immediately.	Wait until the unit restarts automatically. The compressor may hesitate resuming because a three-minute resume prevention circuit is incorporated in the outdoor unit for protection of the compressor.

[for wired remote controller]

Problem	Solution	Problem	Solution
Unit does not cool or heat very well.	Clean the filter.	CENTRALLY CONTROLLED is displayed in the remote controller.	The start and stop functions of the remote controller are not available when the CENTRALLY CONTROLLED message is lit.
The unit stops operating before arriving at the set temperature in the heating mode.	Frost forms when the outdoor temperature is low and humidity is high. Wait for about 10 minutes for the frost to melt.	The start and stop functions are not available just after restarting the unit.	Wait about three minutes (operation has stopped to prevent damage to the air conditioner).
The airflow direction suddenly changes.	After one hour of cooling-mode operation with the airflow in a downward direction, the unit will automatically change to the "Horizontal airflow" mode. When the unit is in the heating or de-frosting mode, it will automatically change to the "Horizontal airflow mode".	"HO" is displayed in the remote controller.	An automatic startup test is being performed (will last for about two minutes).
A white mist is expelled from the indoor unit.	This may occur just after the unit is turned on when a high level of humidity is present in the room.	An error code is displayed in the remote controller. The operating display of the wireless remote controller's receiver is flashing.	A self-diagnostic function is being performed to preserve the air conditioner. * Do not attempt to make repairs yourself. Turn the main switch off and contact the dealer from whom you bought the air conditioner. Provide him or her with the name of the unit and the information displayed in the remote controller.
The indicators of the remote controller do not light up when operated.	Turn on the power switch. ". " will be displayed.		

NOTE: After a power cut, the unit will not restart automatically. You will have to restart it by pressing the POWER - ON/OFF button on the remote controller.

If none of the above apply, turn the main switch off and contact the dealer from whom you bought the air-conditioner, telling him the model name and the nature of the problem. Do not try to fix the unit yourself.

In any of the following cases, turn off the main power switch and contact your local dealer for service:

- The operation lamp (on the main unit) flashes.
- The switches do not work properly.
- The circuit breaker trips frequently (or the fuse blows frequently).
- Water has accidentally been splashed into the unit.
- Water leaks from the unit.
- Something is accidentally dropped into the air-conditioner.
- An unusual noise is heard during operation.

Operating range

		Indoor air intake temperature	Outdoor air intake temperature
Cooling	Maximum	35 °C DB, 22.5 °C WB	46 °C DB
	Minimum	19 °C DB, 15 °C WB	-5 °C DB
Heating	Maximum	28 °C DB	21 °C DB, 15 °C WB
	Minimum	17 °C DB	-11 °C DB, -12 °C WB

The following do not indicate any malfunction:

Odours: smells such as tobacco or cosmetic odours may persist after they have been sucked into the unit.

Sound of liquid flowing inside indoor unit: this can occur during or after operation and is simply the sound of refrigerant being circulated inside the unit.

Ticking sound coming from indoor unit: this can occur when cooling or heating has just begun or has just stopped. It is caused by the indoor unit shrinking or expanding slightly due to the change in temperature.

The message "CENTRALLY CONTROLLED" appearing on the LCD panel: from time to time, this message may come up on the LCD panel. This does not indicate any malfunction.

Remote Controller Settings for Installing/Replacing Batteries and Restarting Operation (for wireless remote controller)

- Always press the reset button after installing or replacing batteries.
- The initial settings are used when installing or replacing batteries after which the settings for restarting are used.

	Initial Settings	Restarting	
Operating mode	Fan	Previous operating mode	
Temperature setting	—	Previous temperature setting	
Fan speed	High	Previous fan speed setting	
Airflow direction	Level	Operating mode	Level
		Cooling - Dry	Level
		Heating	Previous setting
		Fan	Level

NOTE: The refrigerant charged in the air conditioner is safe. Refrigerant normally does not leak, however, if refrigerant gas leaks indoors, and comes into contact with the fire of a fan heater, space heater, stove, etc., harmful substances will be generated. Be sure to ask the service representative whether there is refrigerant leakage or not when repairs are carried out.

5. Specifications

■ PCA-RP-GA+PU(H)-P-GAA

Model	RP2	RP2.5	RP3	RP4	RP5	RP6
Capacity (Cooling/Heating) <kW>*1	5.35/6.20	6.60/7.25	7.45/9.15	9.60/10.60	12.30/14.80	14.20/17.00
Total Input (Cooling/Heating) <kW>*1	2.35/2.36	2.62/2.66	3.37/3.48	3.62/3.81	4.91/5.11	5.89/6.24
Power source (voltage <V>/Frequency <Hz>)	-					
Dimension (Height) <mm>	210			270		
Dimension (Width) <mm>	1000	1310			1620	
Dimension (Depth) <mm>	680					
Fan Airflow rate (Low-Middle2-Middle1-High) <m ³ /min>	10-11-12-13	14-15-16-18		20-21-23-25	27-30-32-34	
Noise level (Low-Middle2-Middle1-High) <dB>	37-38-40-42	37-39-41-43		40-41-43-45	41-43-45-46	42-44-46-48
Net weight <kg>	27	34		37	43	45

■ PCA-RP-GA+PUHZ-RP-HA

Model	RP2	RP2.5	RP3	RP4	RP5	RP6
Capacity (Cooling/Heating) <kW>*1	4.70/5.50	6.00/7.00	7.10/8.00	10.00/11.20	12.50/14.00	14.00/16.00
Total Input (Cooling/Heating) <kW>*1	1.67/1.71	1.63/2.03	2.14/2.43	2.92/3.26	3.89/4.34	4.96/4.60
Power source (voltage <V>/Frequency <Hz>)	-					
Dimension (Height) <mm>	210			270		
Dimension (Width) <mm>	1000	1310			1620	
Dimension (Depth) <mm>	680					
Fan Airflow rate (Low-Middle2-Middle1-High) <m ³ /min>	10-11-12-13	14-15-16-18		20-21-23-25	27-30-32-34	
Noise level (Low-Middle2-Middle1-High) <dB>	37-38-40-42	37-39-41-43		40-41-43-45	41-43-45-46	42-44-46-48
Net weight <kg>	27	34		37	43	45

■ PKA-RP-GAL+PU(H)-P-GAA

Model	RP1.6	RP2
Capacity (Cooling/Heating) <kW>*1	4.45/4.95	5.35/6.20
Total Input (Cooling/Heating) <kW>*1	1.70/1.79	2.33/2.34
Power source (voltage <V>/Frequency <Hz>)	-	
Dimension (Height) <mm>	340	
Dimension (Width) <mm>	990	
Dimension (Depth) <mm>	235	
Fan Airflow rate (Low-Middle2-Middle1-High) <m ³ /min>	9-10-11-12	
Noise level (Low-Middle2-Middle1-High) <dB>	36-38-41-43	
Net weight <kg>	16	

■ PKA-RP-GAL+PUHZ-RP-HA

Model	RP1.6	RP2
Capacity (Cooling/Heating) <kW>*1	3.60/4.10	4.60/4.50
Total Input (Cooling/Heating) <kW>*1	1.03/1.27	1.63/1.40
Power source (voltage <V>/Frequency <Hz>)	-	
Dimension (Height) <mm>	340	
Dimension (Width) <mm>	990	
Dimension (Depth) <mm>	235	
Fan Airflow rate (Low-Middle2-Middle1-High) <m ³ /min>	9-10-11-12	
Noise level (Low-Middle2-Middle1-High) <dB>	36-38-41-43	
Net weight <kg>	16	

5. Specifications

■ PKA-RP-FAL+PU(H)-P-GAA

Model	RP2.5	RP3	RP4
Capacity (Cooling/Heating) <kW>*1	6.45/7.35	7.85/9.40	9.40/10.80
Total Input (Cooling/Heating) <kW>*1	2.65/2.63	3.43/3.61	3.59/3.77
Power source (voltage <V>/Frequency <Hz>)	-		
Dimension (Height) <mm>	340		
Dimension (Width) <mm>	1400	1680	
Dimension (Depth) <mm>	235		
Fan Airflow rate (Low-High) <m ³ /min>	15-20	22-28	
Noise level (Low-High) <dB>	39-45	41-46	
Net weight <kg>	24	28	

■ PKA-RP-FAL+PUHZ-RP-VHA

Model	RP2.5	RP3	RP4
Capacity (Cooling/Heating) <kW>*1	6.00/7.00	7.10/8.00	10.00/11.20
Total Input (Cooling/Heating) <kW>*1	1.55/2.01	1.98/2.40	2.93/3.25
Power source (voltage <V>/Frequency <Hz>)	-		
Dimension (Height) <mm>	340		
Dimension (Width) <mm>	1400	1680	
Dimension (Depth) <mm>	235		
Fan Airflow rate (Low-High) <m ³ /min>	15-20	22-28	
Noise level (Low-High) <dB>	39-45	41-46	
Net weight <kg>	24	28	

■ PU(H)-P-GAA

Model	P1.6V P1.6Y	P2V P2Y	P2.5V P2.5Y	P3V P3Y	P4V P4Y
Power source (voltage <V>/Frequency <Hz>)	V:-/N220-230-240/50, Y:3N-380-400-415/50				
Dimension (Height) <mm>	650	855		1260	
Dimension (Width) <mm>	900				
Dimension (Depth) <mm>	330+20				
Fan Airflow rate <m ³ /min>	45	55	50	85	
Net weight <kg>	54	74	79	97	

■ PUHZ-RP-VHA

Model	RP1.6	RP2	RP2.5	RP3	RP4
Power source (voltage <V>/Frequency <Hz>)	V:-/N220-230-240/50				
Dimension (Height) <mm>	600	943		1350	
Dimension (Width) <mm>	800	950			
Dimension (Depth) <mm>	300+15	330+30			
Fan Airflow rate <m ³ /min>	35	55		100	
Net weight <kg>	45	75		121	

*1 Cooling: Indoor 27 °CDB/19 °CWB, Outdoor 35 °CDB
 Heating: Indoor 20 °CDB, Outdoor 7 °CDB/6 °CWB

This product is designed and intended for use in the residential,
commercial and light-industrial environment.

The product at hand is based on the following EU regulations:

- Low Voltage Directive 73/23/ EEC
- Electromagnetic Compatibility Directive 89/336/ EEC

Please be sure to put the contact address/telephone number on
this manual before handing it to the customer.

This pdf has been downloaded from the website of :

“Supplying and installing the latest in air conditioning technology”

° Celsius
air conditioning

Celsius Air Conditioning Ltd, 1 Well Street, Heywood, Greater Manchester OL10 1NT

 01706 367 500  07000 CELSIUS  01706 367 355  sales@celsiusair.co.uk  www.celsiusair.co.uk

www.celsiusair.co.uk